

BRIAN JAMES TRAILERS

» Connected to you



CARGO CONNECT COMPACT Configure on demand, meet changing needs

Your official distributor :

Alsa Remorques

UNITED KINGDOM

CARGO CONNECT COMPACT



CARGO CONNECT COMPACT

Compact, adaptable transport trailer.

5 5 YEAR
CHASSIS
WARRANTY

Adaptable to meet a vast array of different requirements, all available to be created from a standard base trailer. To provide this adaptability a whole host of new and unique solutions have been developed. We think of it as re-configuration on demand. Every available option can be added or removed at anytime, from brand new, or whenever required in the future.

As well as a uniquely configurable concept, CarGO Connect Compact trailer engineering and quality are exceptional, as is the value for money provided. The result amounts to a trailer fully capable of commercial duty, with longevity of chassis and all critical components well into the future.

Platforms sizes are start at 2.8m through to 3.8m long, in a standard width of 1.90m overall. Several axle and wheel size combinations are available to adapt to almost any requirement.

Professional sales and after-sales support is provided through an extensive network of dedicated Brian James Trailers dealers, able to supply to your exact requirements.



CARGO CONNECT COMPACT

CARGO CONNECT COMPACT

CLICK AND CONNECT, standard features.

CarGO Connect Compact can be set up as you need it to be. This means any available option can be added or removed to suit, as and when needed. CarGO Connect Compact is defined by the concept of configuration, but in addition this brand new design is completed by a multitude of new features and ideas specifically to assist users gain flexibility and an easy operation.

● Multiple anchor and hook points

Strap attachment points are provided along each side of CarGO Connect Compact. Each are located through the chassis for ultimate strength and ease.



● Underside rope hooks

Rope hooks are provided right along the underside of the chassis.

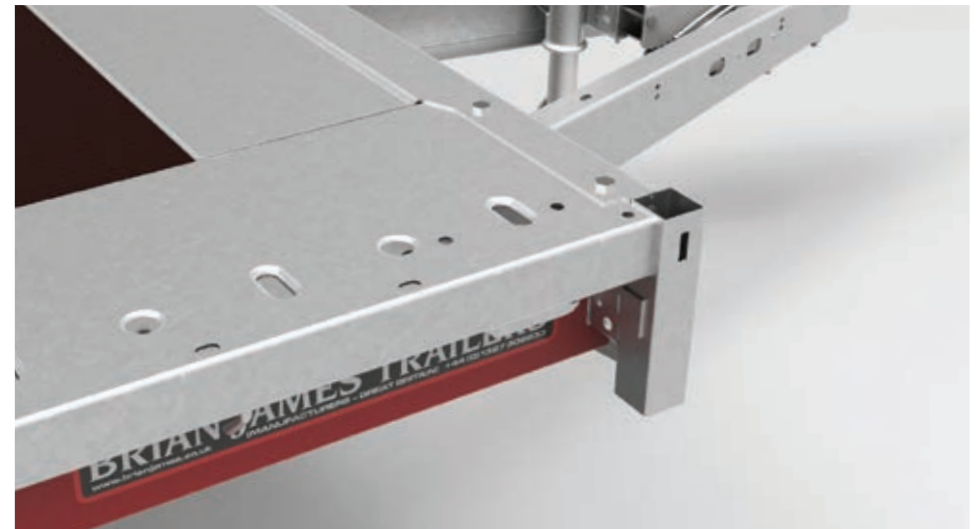

● Connected additions

In every corner and in the centre of the CarGO Connect Compact chassis are high strength 'Connect Nodes'. Each node has the ability to click into place a variety of optional equipment and accessories such as drop side systems, headboards or ladder racks. No tools needed, no fuss.



● **Level ride, matched coupling**

Models with larger wheels are fitted with a lowered draw bar, ensuring that the tow ball is matched to the optimum height for level towing.

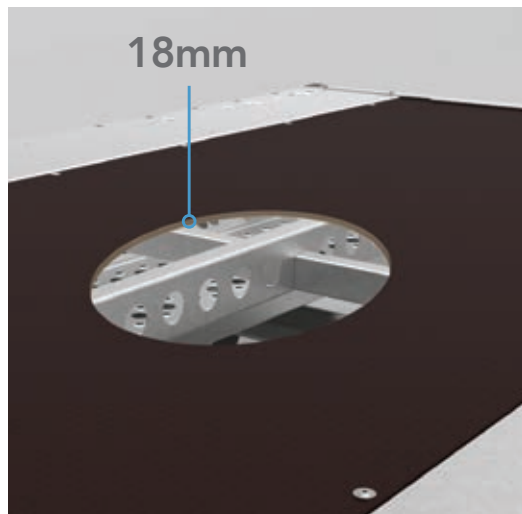

● **Super-Strong**

An 18mm anti-slip phenol ply-deck with a network of chassis supports under the deck ensures that heavy items can be transported.

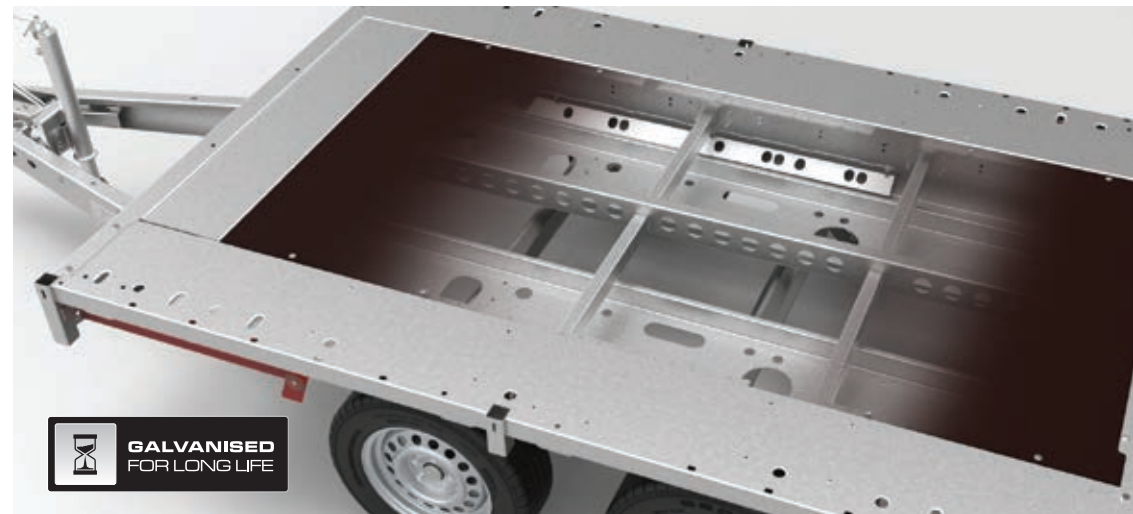

● **Super-Structure**

The durability of CarGO Connect Compact is not just skin deep. Super-strength steel used in the main chassis fabrication, complemented by a longitudinal beam below the 18mm thick phenol ply anti-slip centre bed. Lighter weight and improved strength, combined with the durability of a hot-dip galvanised chassis will remain with the CarGO Connect Compact for many years.



● **Smooth-ride, self damping**

CarGO Connect Compact trailers are designed for long distance and heavy loads. Axles and suspension technology is by AL-KO, Europe's largest trailer equipment manufacturer.

With extensive in-house testing and development facilities in Germany and a history of over 80 years, AL-KO provide an unmatched combination of competence and experience.

CarGO Connect Compact offers the choice of either a 10", 12" or 14" wheel size. Choose 10" for the best in low-loading or 14" when durability is a priority.



● **Individual lamp array**

Stylish, well protected lamps are individually replaceable in the unlikely event of damage. They feature an automotive quality bulb holder providing exceptional durability. A convenient twist release mechanism for easy bulb access is integral to the design. These fully sealed lamps are further protected by a bodywork housing preventing direct wheel spray and a junction box wiring system for easy maintenance.

○ **Upgrade to full LED lighting**

Replace bulbed rear lamps with LED technology. Super bright and extremely durable, multi voltage.

LED lamps: Note

LED lamps may not be compatible with all towing vehicles. Please check compatibility. Electronic 'Lighting Control Gear' is available as an option.



CARGO CONNECT COMPACT

OPTIONS

The most useful and popular option for any multi-use trailer is a set of drop sides. The CarGO Connect Compact side option goes further than ever, with strong, but light steel sides featuring a robust latching mechanism designed to keep everything silent. In addition sides can be extended with mesh panels, or even a double height side option.



○ Drop sides, single height

With a removable headboard, a full set of 0.30m high side panels and securing posts. Panels and posts are fully removable without the need for tools. Every part is designed to last.

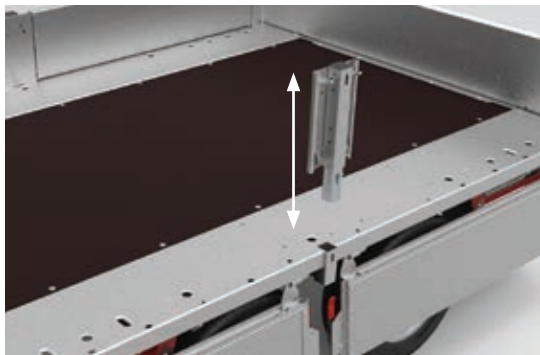

● Toggle catches

Fail-safe, quick release latches. Each latch has its own self adjustment spring to ensure a safe and secure connection.

○ Corner & centre posts

Interchangeable posts can be fitted and removed in seconds and yet remain extremely robust.



● Flush deck

The CarGO Connect chassis and body design provides the perfect design for forklift loading, with no upstanding edges.



○ Front headboard

The strong headboard is easily removable, especially useful for transporting long loads. Heavy boxes and equipment can be positioned against this strong section.



○ Double height, removable sides

'Click and Connect' design allows for an extra set of sides to be fitted directly on-top of a single height side.



○ Mesh side extensions

Specifically designed for light weight easy handling, these mesh panels will transform it's ability to transport bulky, lighter items. With a mesh panel kit the sides are extended by 0.72m and when combined with drop sides, totals 1.02m.



○ Long mesh ramp with high mesh side extensions

Combining a long tail ramp, single height drop sides and high mesh side extensions makes an ideal solution for the varied requirements of many landscaping operations.



○ Mesh sides, standalone

CarGO Connect Compact offers configuration flexibility, so for example mesh side panels can be fitted as a standalone feature*. This will benefit for the transportation of scrub and brush materials in site clearance or maintenance operations.

**Standalone mesh side panels are not available in combination with a tail ramp.*



○ Long mesh ramp

A full width, long mesh ramp (1.8m) offers ultimate convenience for flat-bed loading. Choose this option with 10" trailer wheels for a simple, low loading facility.

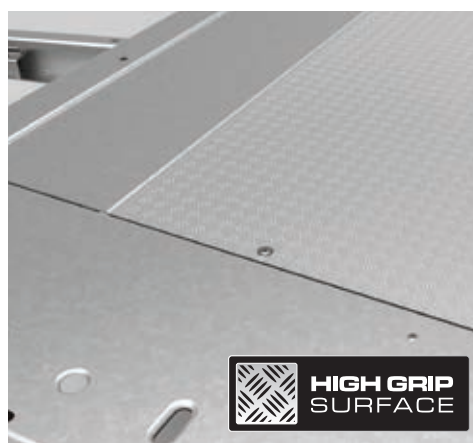

○ Aluminium deck

An overlay for the standard deck protecting it from abrasive use.

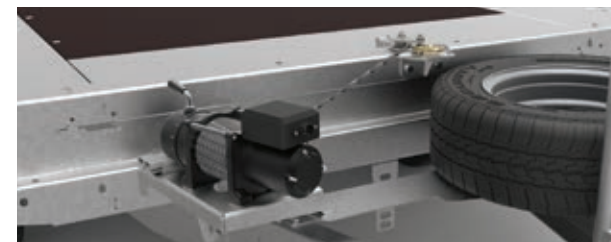

○ Electric winch, 12v high capacity

Electric winch, is powered by a portable 12v power pack, available separately. Remote control operation, with free spool and roller guides.

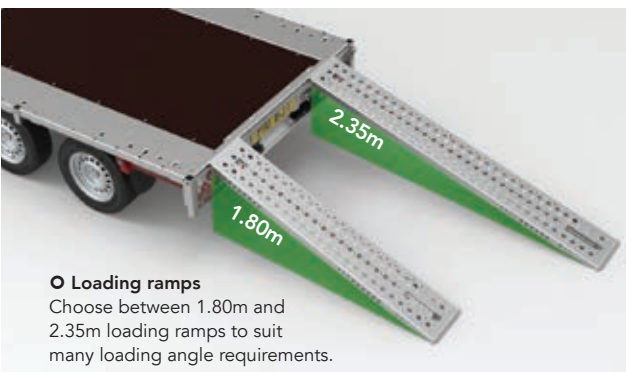

○ Loading ramps

Choose between 1.80m and 2.35m loading ramps to suit many loading angle requirements.



○ Rear support stands

Specify rear stands on flat-bed trailers to provide support when loading heavy equipment.



○ Ladder racks

A configurable ladder rack system gives options to add a ladder rack to a mesh kit, or have it standalone. Several racks can also now provide a unique option for various purposes.



○ Manual winch, with centre pull

A manual winch with auto-brake and a removable handle for free-spool release of the cable. The centrally located and articulated pulley block ensures every loading operation runs smoothly.

CARGO CONNECT COMPACT

- **Reinforced deck**

constructed with a chassis super-structure and an 18mm ply deck featuring a high grip, anti-slip surface

- **High mesh extension panels**, extend the total height to 1.02m

- **Tail ramp**, full width high strength steel ramp features very durable punched and formed grip surface. Easy handling with assistance from side springs

- **Spare wheel** mounted conveniently at the front of the trailer.

- **Heavy duty** running gear manufactured by AL-KO and featuring sealed wheel bearings ensures minimum maintenance

Precision engineering ensures long-term durability. High strength materials in the chassis combined with class leading axles manufactured by AL-KO guarantees stable, comfortable and highly dependable performance.

- **Double height** sides allows for an extra set of sides to be fitted directly on-top of a single height side.

- **Drop sides** provide a strong and convenient 0.3m high side. Flat inside surface for easy cleaning.

- **50mm ball coupling head.**

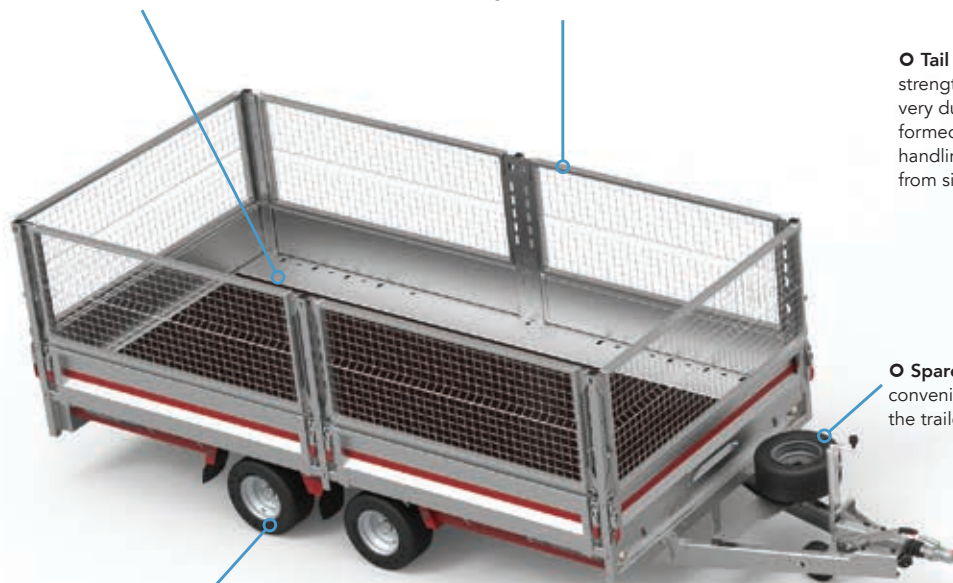

TECHNICAL INFORMATION.

LOAD BED LENGTH M A	2.80		3.30		3.80		
CAPACITY							
Gross kg	2,600	2,700	1,500	2,600	2,700	2,600	2,700
Load kg	2,093	2,188	1,040	2,065	2,158	2,015	2,108
Unladen trailer weight kg	507	512	460	535	542	585	592
DIMENSIONS							
Internal bed width m B	1.80	1.80	1.80	1.80	1.80	1.80	1.80
Overall trailer width m C	1.90	1.90	1.90	1.90	1.90	1.90	1.90
Overall trailer length m D	4.26	4.26	4.76	4.76	4.76	5.30	5.30
Bed load height m	0.68	0.55	0.62	0.68	0.55	0.68	0.55
Towball height (loaded, centre of towball) m	0.42	0.40	0.42	0.42	0.40	0.42	0.40
RUNNING GEAR							
Axles	2	2	1	2	2	2	2
Wheel / Tyre size	13" (165R13)	10" (195/55)	12" (195/60)	13" (165R13)	10" (195/55)	13" (165R13)	10" (195/55)
Spare wheel	○	○	○	○	○	○	○
Auto retract jockey wheel	●	●	●	●	●	●	●
BED OVERLAY							
Aluminium tread plate deck overlay - Fits between steel chassis, covers wooden sections to provide durable surface	○	○	○	○	○	○	○
REAR LOADING							
Loading ramps, 1.80m*	○	○	○	○	○	○	○
Loading ramps, 2.35m*	○	○	○	○	○	○	○
Loading ramp, full width*	○	○	○	○	○	○	○
Rear kick down support legs*	○	○	○	○	○	○	○
DROP SIDES, SIDE OPTIONS							
Headboard, removable*	○	○	○	○	○	○	○
Connect drop side system*	○	○	○	○	○	○	○
Connect extended side, double height*	○	○	○	○	○	○	○
Connect extended side, mesh kit, 0.72m*	○	○	○	○	○	○	○
Ladder rack*	○	○	○	○	○	○	○
WINCH							
Manual Winch Kit*	○	○	○	○	○	○	○
Electric Winch Kit, no Power System*	○	○	○	○	○	○	○
Electric Winch Kit, with Power System*	○	○	○	○	○	○	○
LOADING, WHEELS AND SECURITY							
Tie-down straps - heavy duty	○	○	○	○	○	○	○
Cast steel coupling head with integral high security lock	○	○	○	○	○	○	○
LED lighting, full rear lighting kit, multi-voltage	○	○	○	○	○	○	○
Axle Dampers Fitted	○	○	○	○	○	○	○
Wheels-Safety kit – torque wrench + digital tyre pressure gauge	○	○	○	○	○	○	○
Tyre pressure monitoring system – TPMS by TyrePal in-car monitor with external sensors	○	○	○	○	○	○	○
Datatag – Security identification system	○	○	○	○	○	○	○
Tracker – Anti theft device by SureTrack with full time monitoring 24/7	○	○	○	○	○	○	○
7 pin socket to 13 pin plug adapter	○	○	○	○	○	○	○
PRODUCTS							
Product code	470-1221	470-1222	470-2111	470-2221	470-2222	470-3221	470-3222

* Item in kit, this option incurs an additional dealer 5% fitting charges

● Standard ○ Optional at extra cost

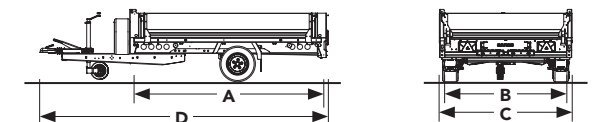

CARGO CONNECT COMPACT

QUALITY

Brian James Trailers are manufacturers of class leading trailers, since 1979. When you buy a Brian James Trailer you can be absolutely certain that it is designed and constructed to the highest possible standards. Our Engineers combine top-quality craftsmanship with the best materials and first-class presentation. Light but strong, our trailers are crafted to enhance safety, efficiency and durability.

5 Year Chassis Warranty

This Brian James Trailer is provided to you with a non-transferable manufacturers warranty covering the integrity of the chassis for a period of 5 years from the date of first purchase.

We warrant that under normal use, outside of accident damage or misuse (meaning driven across unsuitable territory or being overloaded) the chassis will not fatigue or fail to be able to perform its intended duties safely.

Any repair or rectification as a result of a claim under this warranty will be at Brian James Trailers cost and be carried out either at a Brian James Trailers main dealer, or at the factory HQ in Daventry, UK, at the discretion of Brian James Trailers Ltd. A repair may involve removal of the original galvanised surface finish, for which we will not liable to reinstate to its original state.

Brian James Trailers will not be liable for any consequential loss in connection with a claim on this warranty, including recovery fees or transport to or from the place of final repair.

5 **5 YEAR
CHASSIS
WARRANTY**

**CARGO CONNECT COMPACT
AS YOU NEED IT**





BRIAN JAMES TRAILERS

» Connected to you

Your official dealer :

ALSA REMORQUE - BRIAN JAMES ALSACE

22 route de Colmar

67600 Sélestat

Tél. 03 88 92 02 19 GSM 06 47 12 84 90

<https://www.alsa-remorque.fr>

info@alsa-remorque.fr

<https://www.brianjamesalsace.fr>

brian.james.alsace@gmail.com

NOTES

Specifications are subject to change without notice.
Illustrations and photography may depict optional

© BRIAN JAMES TRAILERS LIMITED.

Edition CGCOMP2019_Q1_1

Brian James Trailers Limited.

Sopwith Way, Drayton Fields Industrial Estate
Daventry, Northampton, NN11 8PB

Brian James Trailers are available by contacting our sales team as well as through an extensive network of official dealers throughout the country.

Your official dealer :

Alsa Remorque

